

Local Area Networks

Jan Janeček

Dept. of Computer Science & Engineering

Czech Technical University Prague

`janecek@cs.felk.cvut.cz`

February 26, 2006



VLAN - Virtual LAN

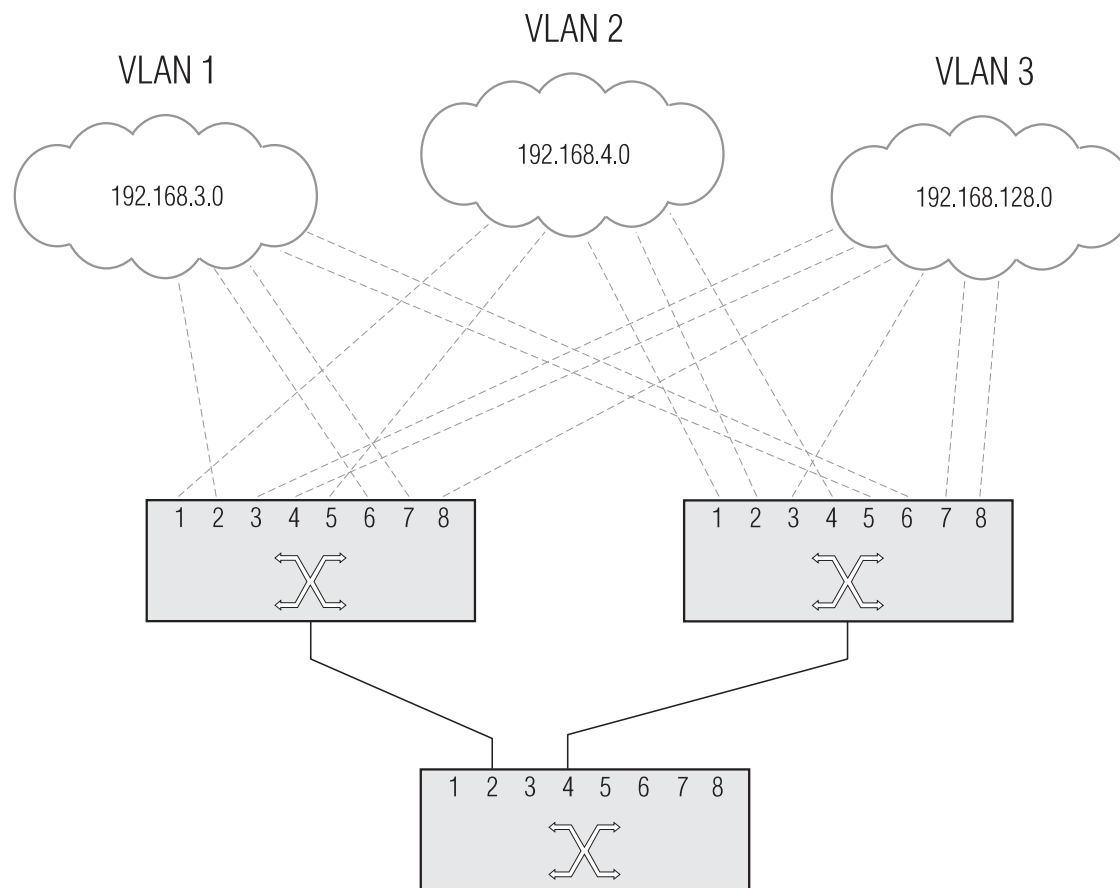

VLAN - Virtual LAN

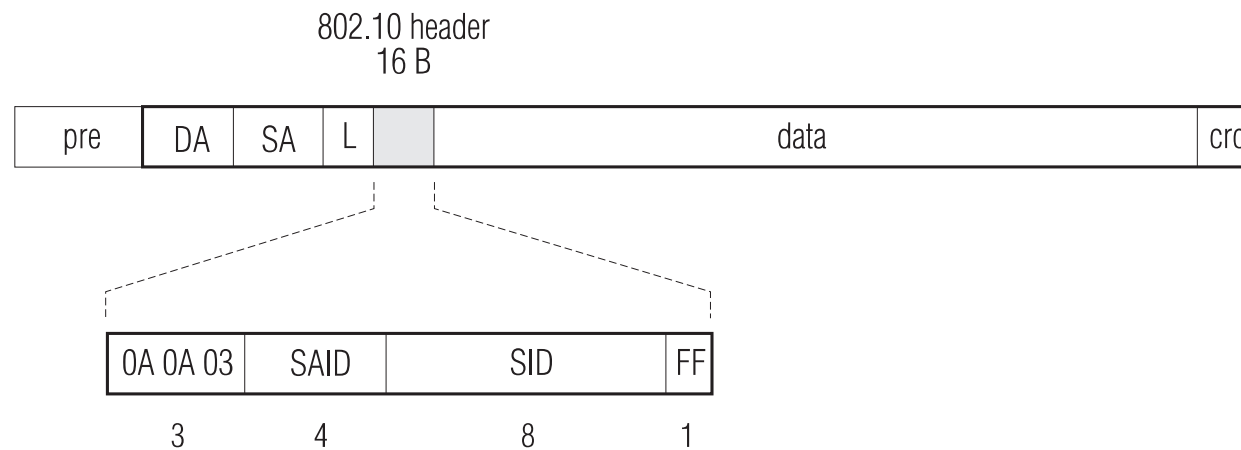

SAID Security Association ID

SID (Source) Station ID

FF Fragmentation Flag



VLAN - Virtual LAN

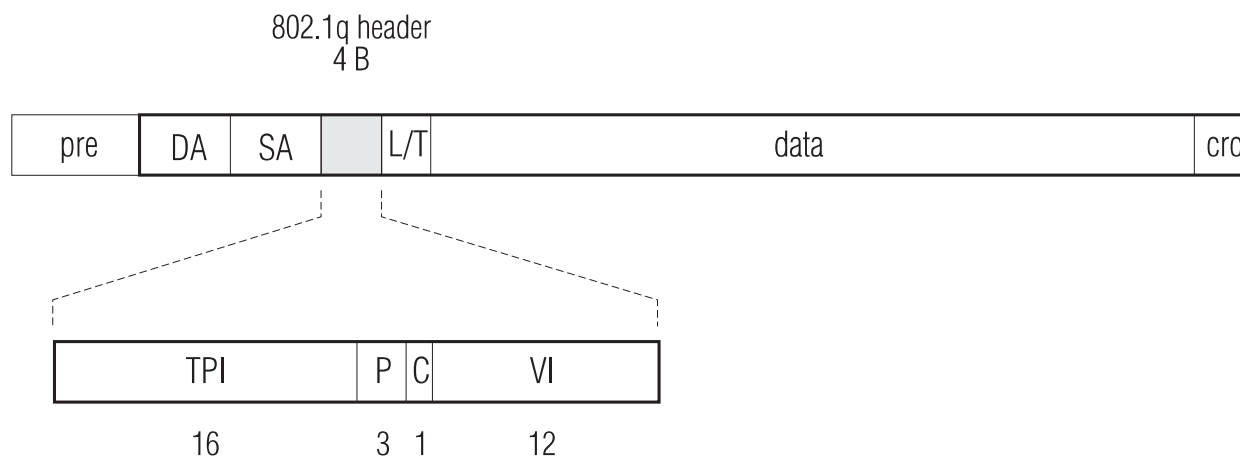

TPI Tag Protocol Identifier (8100) H

P Priority

C Canonical Format Indicator

VI VLAN Identifier



VLAN - Virtual LAN

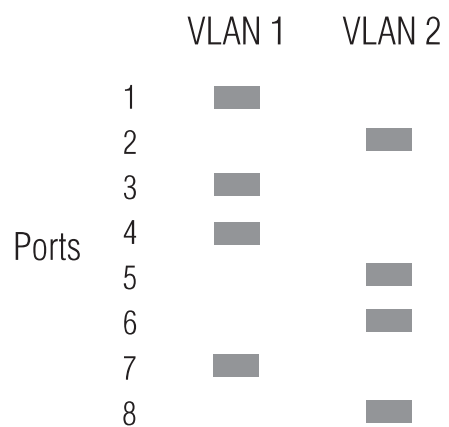

a)

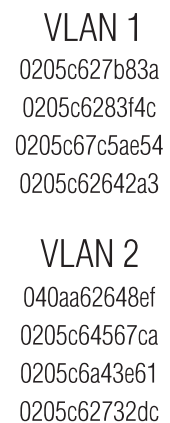

b)



c)



DQDB - Double Queue Double Bus

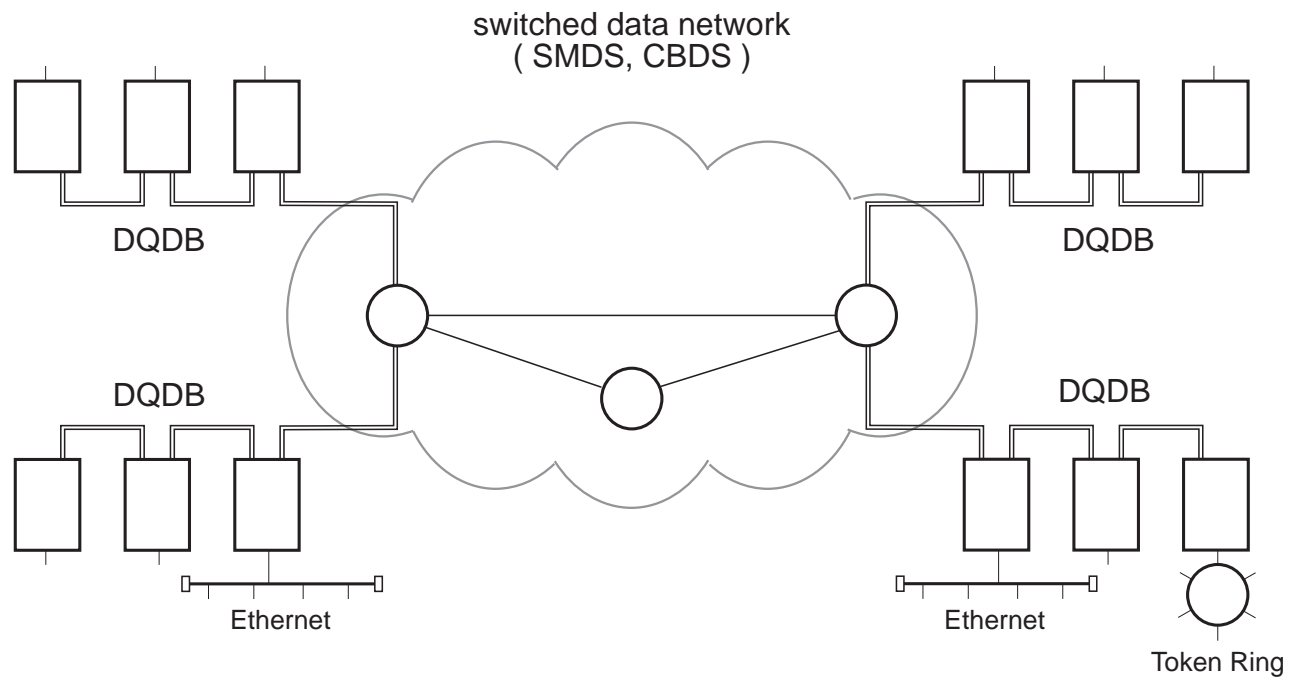

DQDB - Double Queue Double Bus

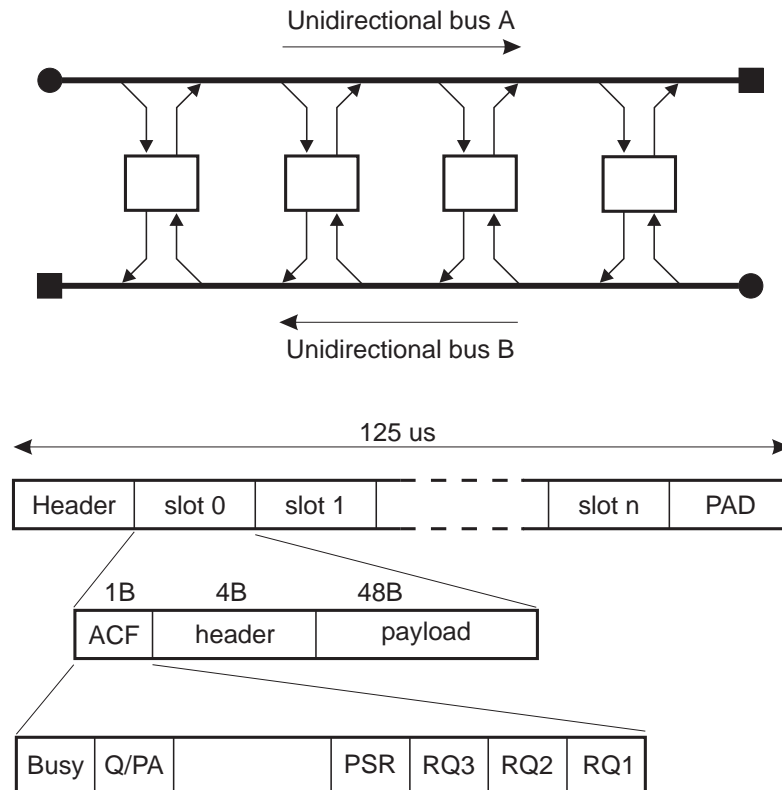

DQDB - Double Queue Double Bus

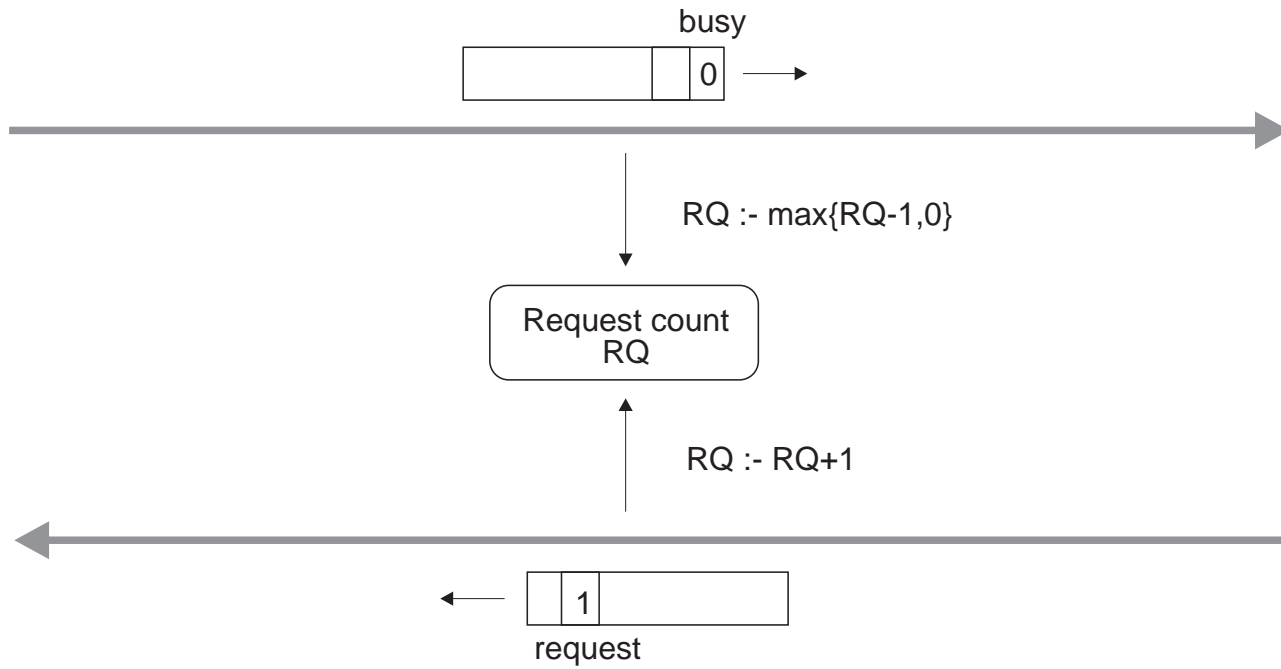

DQDB - Double Queue Double Bus

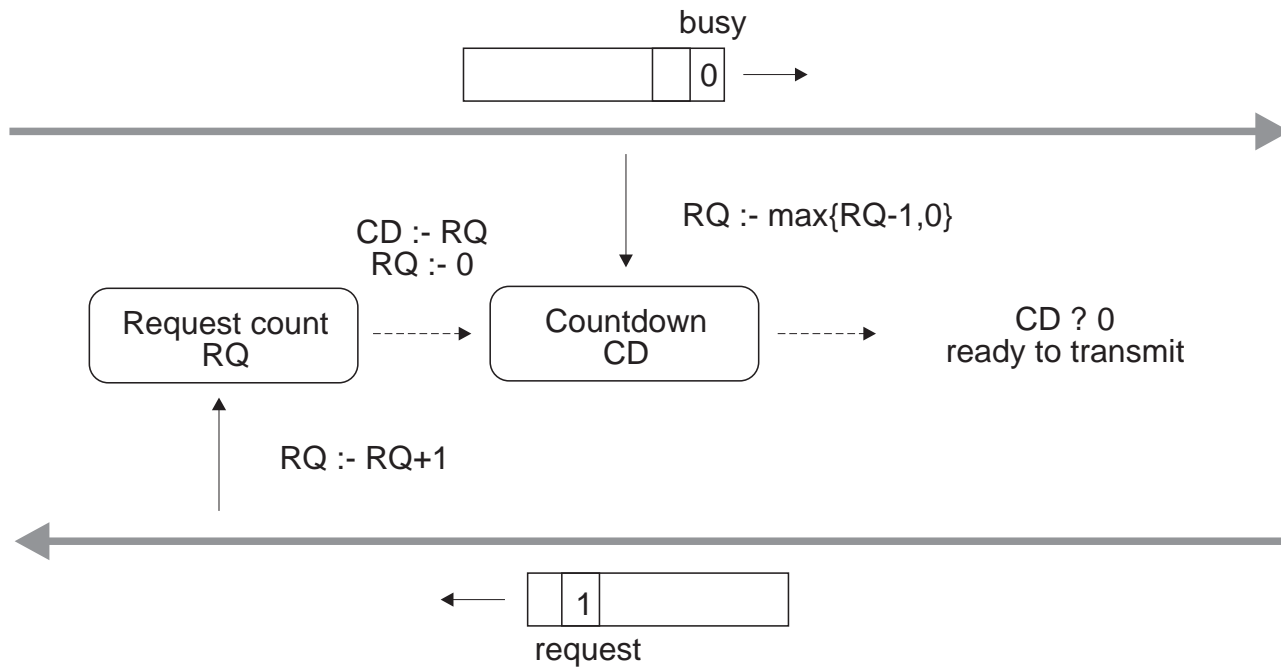

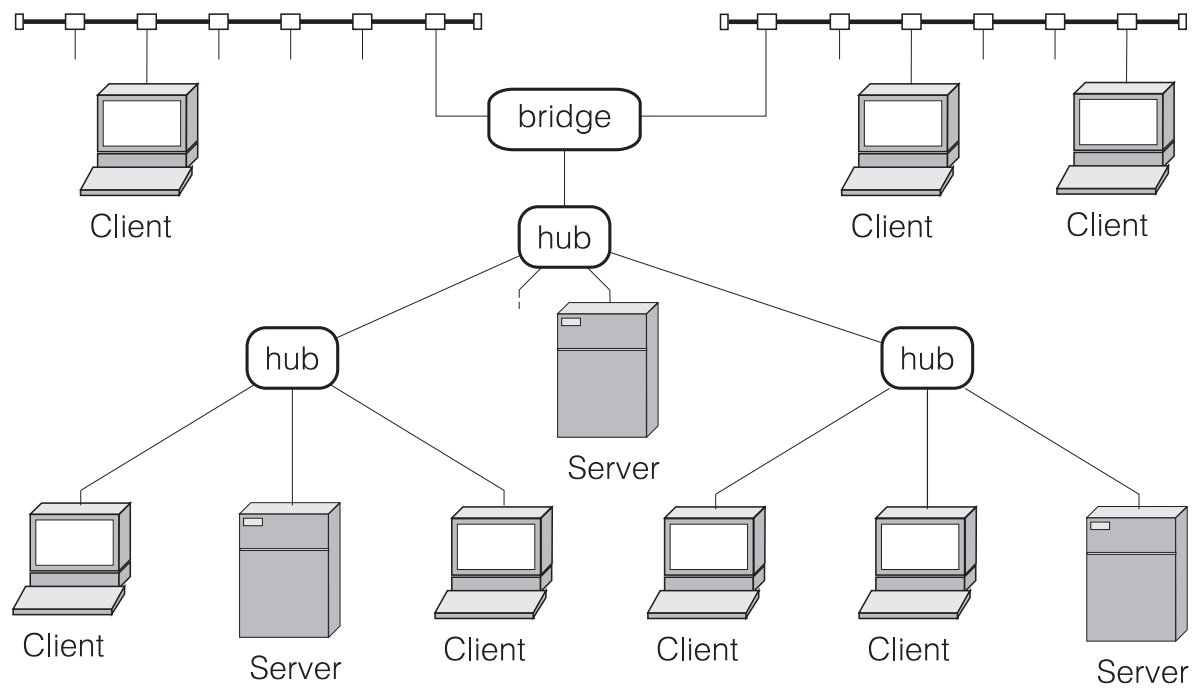

IEEE 802.3
Ethernet



MAC

IEEE 802.5
Token Ring

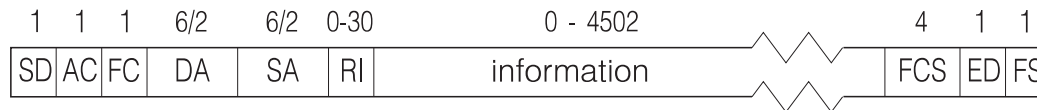

channel

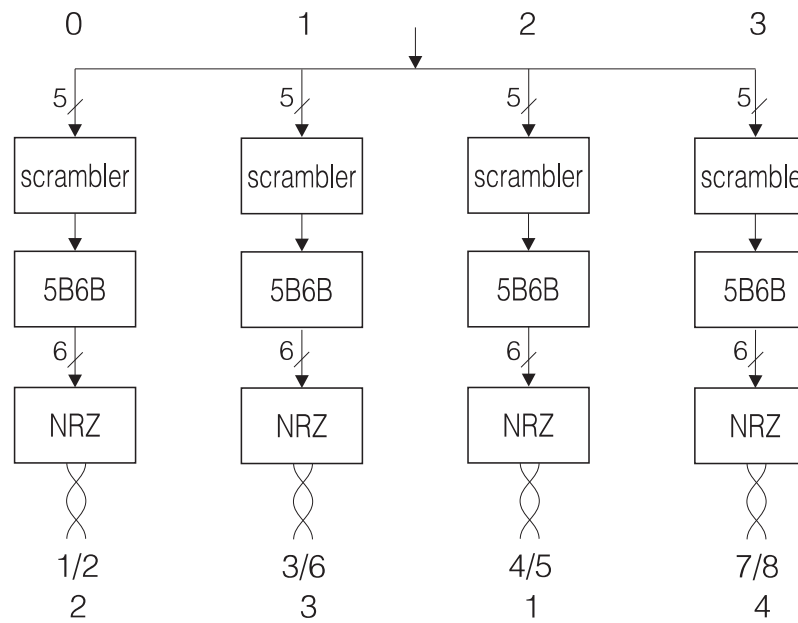

PMI
(medium independent)

PMD
(medium dependent)

wires
pair



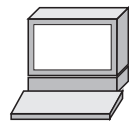
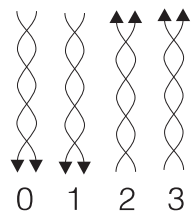

Station

signals

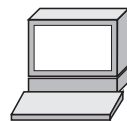
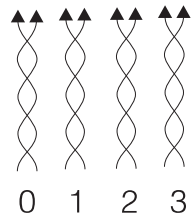

Station

sending
data

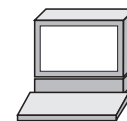
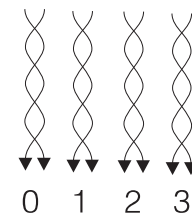
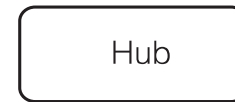

Station

receiving
data



